

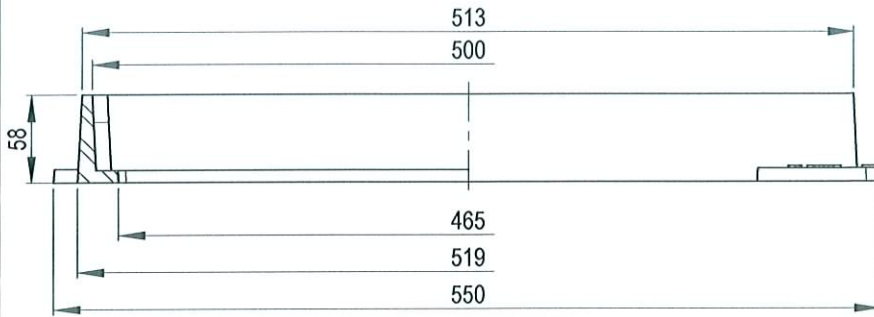

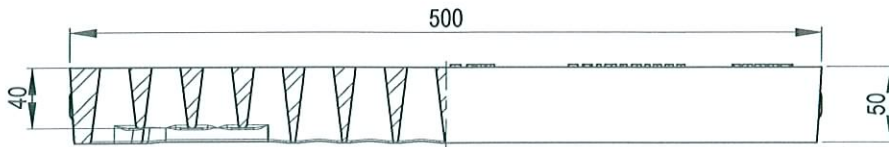

A-A

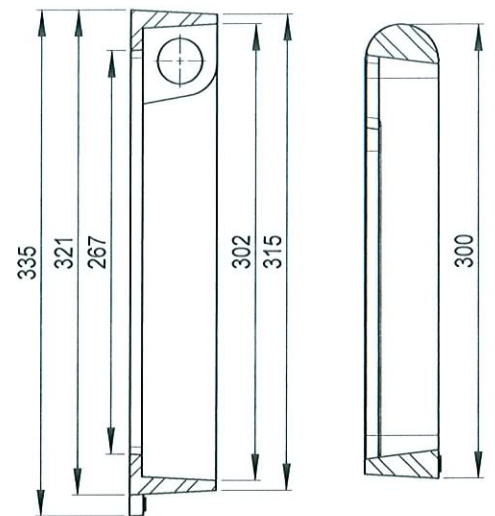
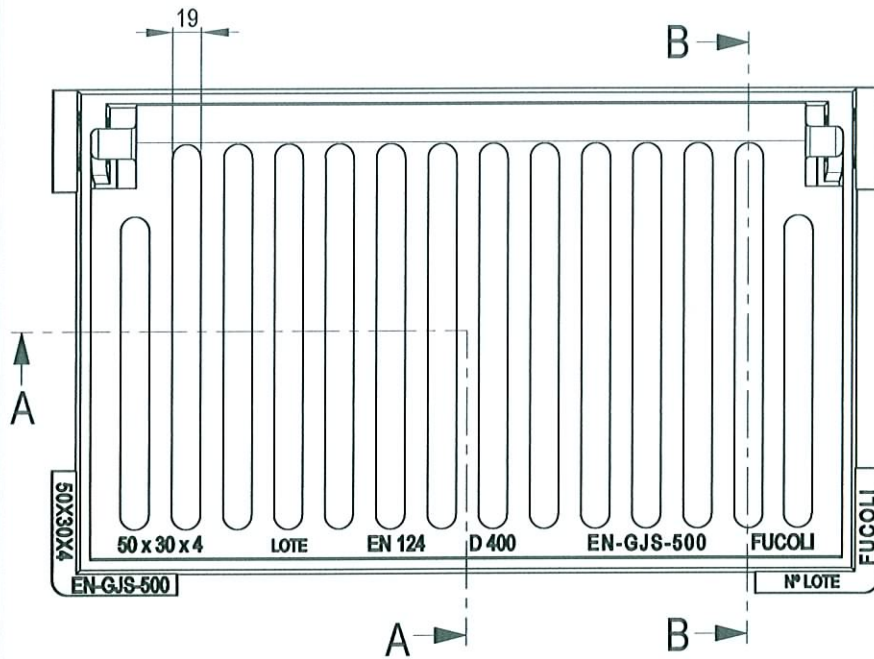

B-B



GRELHA **19,1** Kg (cód. 203.06.028)
 PESO APROX.
 ARO **7,8** Kg (cód. 203.09.083)

	DATA	RÚBRICA	MATERIAL	 Fucoli - Somepal <small>FUNDIÇÃO DE FERRO S.A.</small>
DESENHOU	23/07/2010		FERRO FUNDIDO NODULAR (DÚCTIL)	
APROVOU	23/07/2010			DESENHO Nº
ESCALA	DESIGNAÇÃO			203.03.018
TOLER. ISO 8062 CT 9	GRELHA+ARO 50x30x4 D400 N A-R T/ALQUEVA			REV. Nº 4 FOLHA 1 DE 1
				SUBSTITUI REV. 3
				SUBSTITUIDO POR